

PLAN

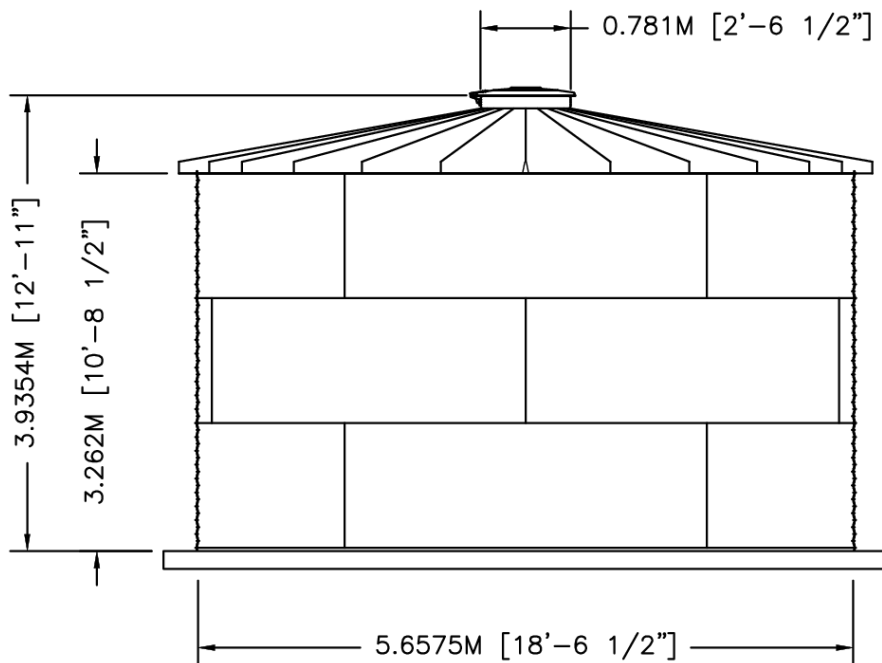

ELEVATION



	BY	DATE	TITLE	
DWN	XXX	XX/XX/XX	WTU06-03 30"PR 10DEG V-RIB	
CKD			NOMINAL CAPACITY - 78.858 M3 [20,832 GAL]	
ENG			DWG. NO. SCT1803-LVR WTU06-03	REV. NO.
	SIZE: A	SCALE: 3/16"=1'-0"	SHEET 1	OF 1